

respekta®



D

Montageanleitung

Insel Dunstabzugshauben

GB

Installation Instruction

Island Cooker hoods







Mod. No.:

CH 11050 ISB

CH 11050 IWB

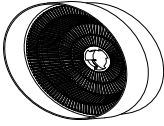
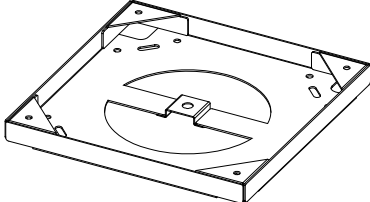
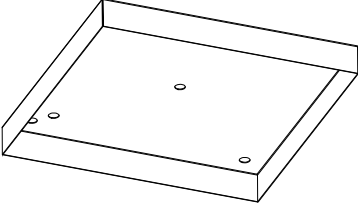
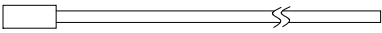
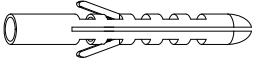
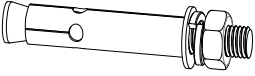
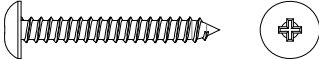
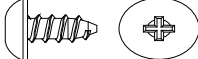
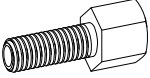
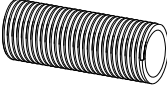
fi200605atNEG

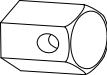
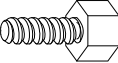
SY-132D2IW-E4r-C59-L52-500

No.	Name	Abbildung	Anzahl
1	Aktiv Kohlefilter		2
2	Decken Montageplatte		1
3	Montageplatte Abdeckung		1
4	Drahtseil		4
5	Beton Dübel		8
6	Exzentrerschraube sφ6 x 60mm		4
7	Senkkopfschrauben ST6 x 40 (4 davon für Montage der Montageplatte an einer Beton Decke / 8 für Montage an einer Holzdecke)		8
8	Senkkopfschrauben ST4 x 8mm		4
9	Verstellbare Schrauben M5 x 28		4
10	Schraubzylinder M10 x 30		1
11	Schraubenmutter M10 x 14		2
12	Drahtseilklemme M4		4
13	Drahtseil Fixierungsschraube M4 x 10		4
14	M10 Rändelschraube zum Fixieren der Montageplatte Abdeckung		1
15	Kabelbinder 8 x 30		2

ACCESSORY LIST







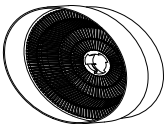
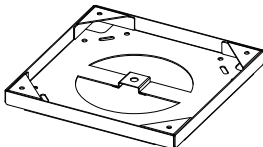
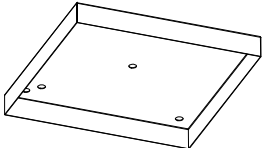
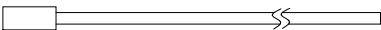
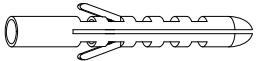

GB

respekta[®]

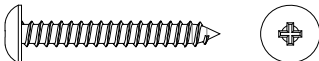
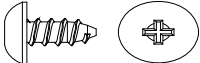
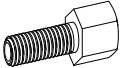
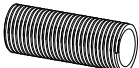
Island Cooker hoods

CH 11050 ISB

CH 11050 ISW

No.	Name	Picture	Qty
1	Charcoal filter		2
2	Mounting plate		1
3	Decorative plate		1
4	Wire rope		4
5	Wall plug (for mounting the mounting plate on a concrete ceiling)		8
6	Eccentric screw $\phi 6 \times 60 \text{mm}$		4
7	Countersunk screws ST6 x 40 mm (4 pcs for mounting the mounting plate on a concrete ceiling / 8 pcs for mounting on a wooden ceiling)		8
8	Countersunk tapping screws ST4x8mm		4
9	Wire rope adjustable screws M5*28		4
10	Screw barrel M10*30		1
11	Screw M10*14		2
12	Wire rope lock screw M4		4
13	Wire rope lock screw M4*10		4
14	M10 screw for decorative plate fixing		1
15	Ribbon 8*30		2

Modells: **CH 11050 ISB**
CH 11050 IWB

respekta®



Observe the safety distance between the hob and hood. (Chapter 11.1 in the user's manual)

The ceiling must can bear at least 120KGs weight, and the thickness of the ceiling must be $\geq 30\text{MM}$.

Electrische Installation

All the installation must be carried out by a competent person or qualified electrician. Before connecting the mains supply ensure that the mains voltage corresponds to the voltage on the rating plate.

Direkter Stromanschluss

The appliance must be connected directly to the mains using an omnipolar circuit breaker with a minimum opening of 3mm between the contacts.

The installer must ensure that the correct electrical connection has been made and that it complies with the wiring diagram.

The cable must not be bent or compressed.

Regularly check the power plug and power cord for damage. If the supply cord is damaged, it must be replaced by a special cord or assembly available from the manufacturer or its service agent.

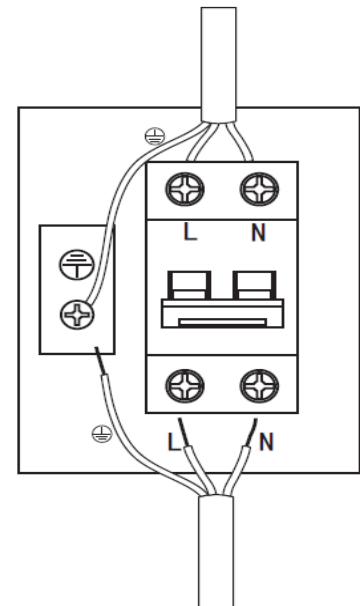

This appliance is supplied with a 3 core mains cable without plug, coloured as follows:

L = Live	brown
N = Neutral	blue
 = Earth	yellow/green



For safety reasons, only use the mounting parts and fastening screws of the same size recommended in this installation manual.

Failure to install the screws or fixing device in accordance with these instructions may result in electrical hazards.

To install the extractor hood on a concrete ceiling, proceed as follows:

1. Use the enclosed drilling template and mark the 4 drill holes for the mounting plate (B) with a pencil on the ceiling

2. Drill the 4 required holes (10mm / approx. 65mm deep) in the ceiling.

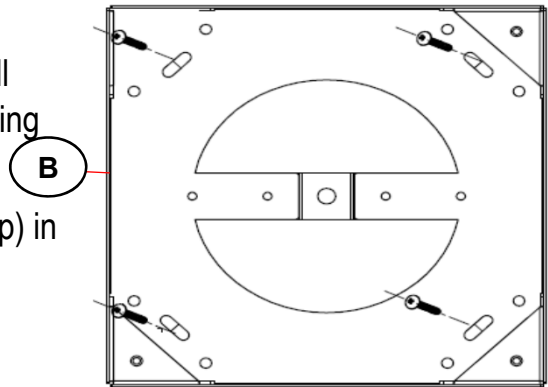

3. Place one dowel in each of the 4 drill holes.

4. Attach the screw cylinder to the mounting plate (B) and attach the screw cylinder to the suspension plate from above and below using 2 M10 nuts (Fig. B2). Make sure that the screw cylinder is not higher than the top of the mounting plate to insure the installed level of the plate.

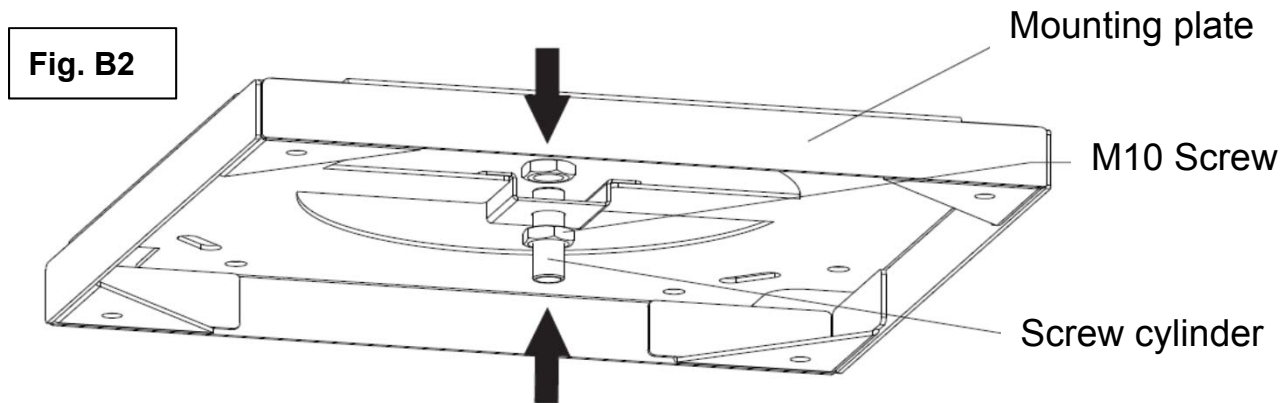

5. Follow steps 1 and 2 (Fig.B3) to insert the end of the 4 wire ropes into the slots on the top plate of the extractor hood, and use 4 pcs ST4 * 8mm countersunk screws to lock the wire ropes, to avoid slide out.

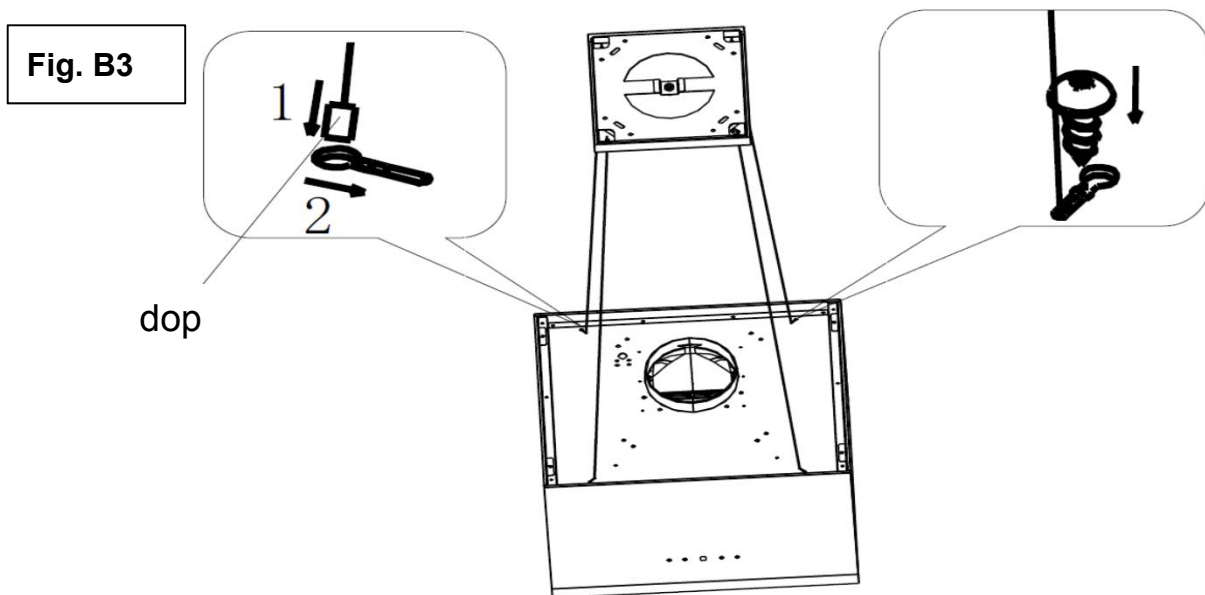

6. Guide the 4 wire cables through the holes **1** in the suspension plate cover, the device cable through hole **2** and mount the supplied connector on the device cable. Then run the device cable through the recess **3** in the mounting plate. (Fig. B4)

From now on, the presence of 2-3 people is required. One or two of them for lifting and holding the hood body and one for the final assembly of the cooker hood.

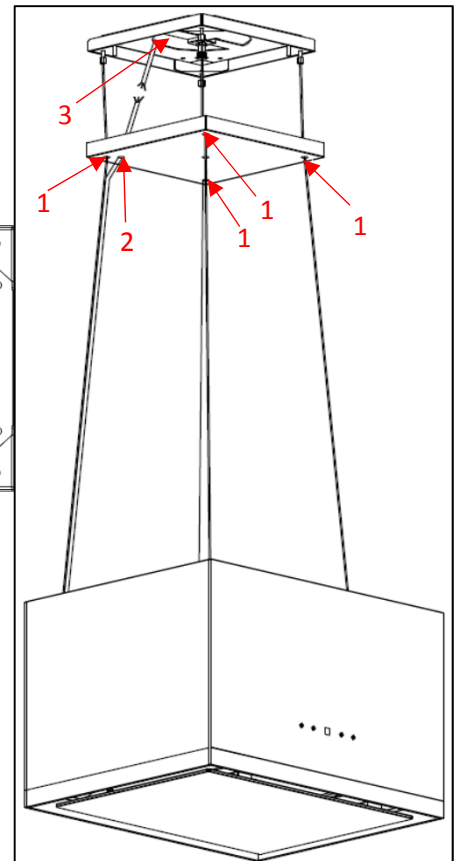
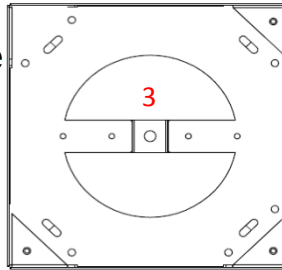

7. Have one or two helpers to bring the hood body up to an appropriate height, so that the following assembly steps can be carried out.

8. Insert the device plug into the socket

9. Mount the mounting plate on the ceiling with 4 ST6 x 40 mm screws (Fig. B)

10. Attach the 4 adjustable screws to the suspension plate, turn them to the correct length and not too tight. Pass the 4 wire ropes through the 4 adjustable screws, determine the length of the wire ropes and mark them. Use 4 wire locking screws + nuts to secure them to the 4 wire ropes at the marked locations. Make sure here that the 4 wire ropes are the same length. (Fig. B5)

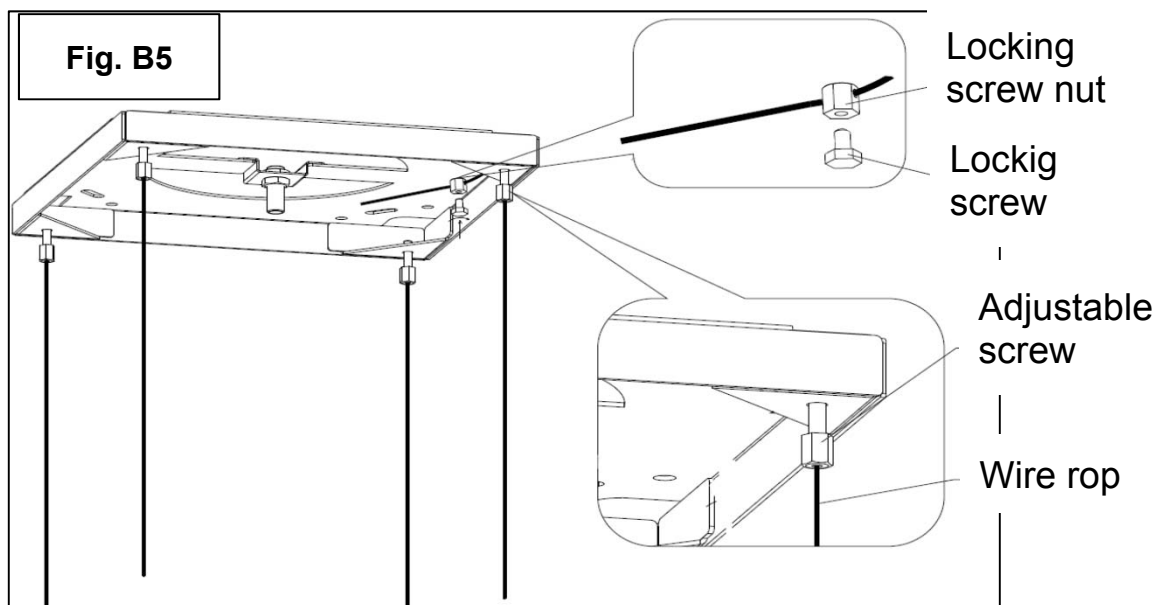

11. Slide the mounting plate cover over the mounting plate and fix it with the fixing screw (Fig B5)

12. If necessary, adjust the length of the wire ropes using the adjustable screws, so that the hood body hangs horizontally.

13. Make sure the carbon filters (F) are on the motor.

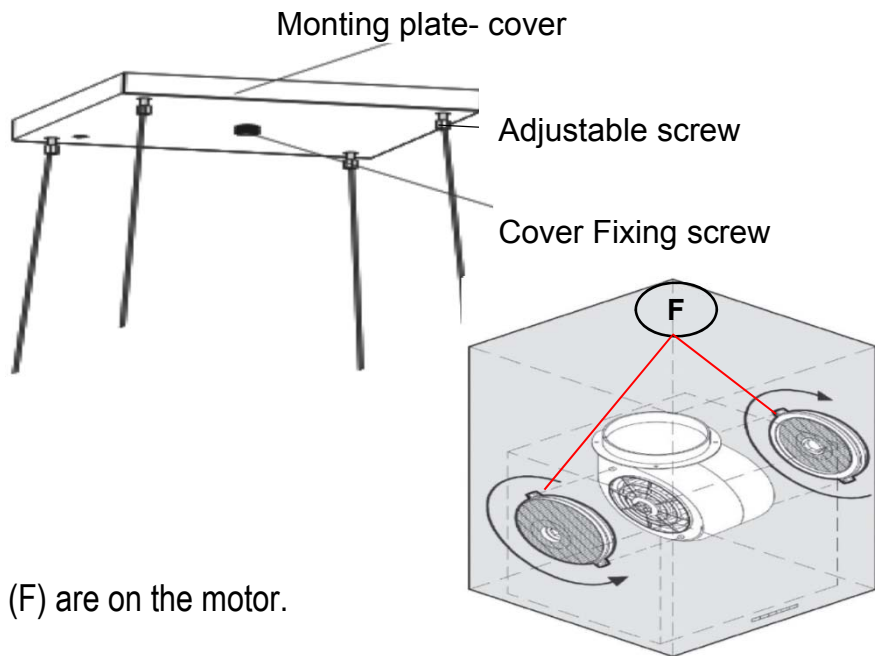

Proceed as follows to install the Cooker hood on a wooden ceiling:

If there is already a cable on your wooden ceiling for the direct connection of the device cable, proceed with the hood assembly as described above. You don't need to read any further.

You can also mount the hood on an existing wooden ceiling without an existing connection cable on it.



For this you need a socket for a Schuko plug CEE 7/7 (A) and a screwable Schuko plug for the electrical connection, which are not included in the scope of delivery.

To install the coocer hood proceed as follows:

STOP The ceiling must can bear at least 120KGs weight, and the thickness of the boards must be at least 19 mm

A) Use a hole saw to make a not too large recess for the device cable, where the hood is to be installed.

B) Remove the wooden panels on the ceiling to the point where you made the recess for the device cable.

C) Run a power cable on the ceiling above the suspended wooden ceiling to the place where the device is to be installed and install a socket there.

STOP Make sure that the power cable is not live during assembly. (Switch off fuse)

D) Reassemble the removed wooden panels in the appropriate order.

Then follow the following assembly steps:

1. Use the enclosed drilling template and mark the 8 drill holes for the mounting plate (B) with a pencil on the suspended ceiling.

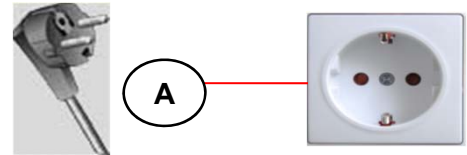

2. Lightly pierce the points for the 8 screws (B) with an eel.

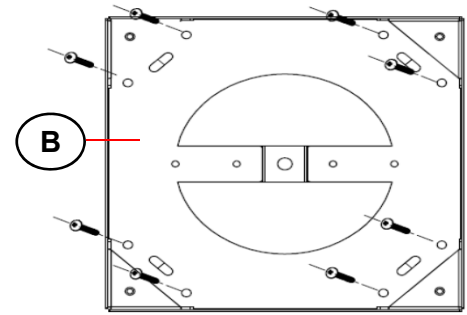
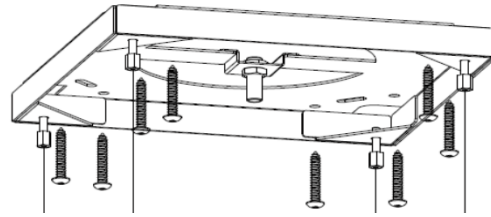

3. Then follow the installation steps 4. to 13. in the above section *"Mounting the extractor hood on a concrete ceiling"*. However, please note that the mounting plate must be fastened with 8 screws on a wooden ceil.